

Development of Greenhouse Monitoring using Wireless Sensor Network through ZigBee Technology

A. Salleh¹, M. K. Ismail², N. R. Mohamad³, M. Z. A. Abd Aziz⁴, M. A. Othman⁵,
M. H. Misran⁶

^{1,2,3,4,5,6}Center for Telecommunication Research & Innovation (CeTRI), Faculty of Electronic & Computer Engineering, Universiti Teknikal Malaysia Melaka (UTeM), Hang Tuah Jaya, 76100, Melaka, Malaysia

ABSTRACT: Greenhouses are often used for growing flowers, vegetables, fruits, and tobacco plants. Most greenhouse systems still use the manual system in monitoring the temperature and humidity in the greenhouse, a lot of problems can occur not for worker but also affected production rate because the temperature and humidity of the greenhouse must be constantly monitored to ensure optimal conditions. The Wireless Sensor Network (WSN) can be used to gather the data from point to point to trace down the local climate parameters in different parts of the big greenhouse to make the greenhouse automation system work properly. This paper presents the design of low cost greenhouse monitoring system to monitor a greenhouse temperature and humidity parameters by applying the ZigBee technology as the WSN system. During the design process, Peripheral Interface Controller (PIC), LCD Display and Zigbee as the main hardware components is used as hardware components while C compiler and MP Lab IDE were used for software elements. The data from the greenhouse was measured by the sensor then the data will be displayed on the LCD screen on the receiver which support up to 100 m range. By using this system, the process of monitoring is easier and it also cheaper for installation and maintenance. The feasibility of the developed node was tested by deploying a simple sensor network into the Agriculture Department of Melaka Tengah greenhouse in Malaysia.

KEYWORDS: Greenhouse monitoring, humidity, temperature, wireless sensor network, ZigBee

I. INTRODUCTION

A greenhouse is a building where plants are grown. Greenhouse protects crops from too much heat or cold, shield plants from dust storms and blizzards, and help to keep out pests. Light and temperature control allows greenhouse to turn in arable land into arable land, thereby improving food production in marginal environments. Fig. 1 shown example of greenhouse that allow certain crops to be grown throughout the year, greenhouses are increasingly important in the food supply of high latitude countries. The closed environment of the greenhouses has its own unique requirements, compared with outdoor production. Pests and diseases, and extremes of the heat and humidity, have to be controlled, and irrigation is necessary to provide water. Significant inputs of the heat and light may be required, particularly in the winter production of warm weather vegetables. Because the temperature and humidity of greenhouses must be constantly monitored to ensure optimal conditions, a WSN can be used to gather data remotely. The data are transmitted to a central location and used to control heating, cooling, and irrigation systems [1].



Figure 1. Greenhouse concept

In the past few years, automatic irrigation system has seen a rapid growth in terms of technology. This system has simpler features designed with the objective of low cost and effective with less power consumption using sensors for remote monitoring and controlling devices which are controlled via SMS using a Global System for Mobile (GSM) and Bluetooth module [2]. This Bluetooth module eliminates the usage charges by communicating with the appliances via Bluetooth when the application is in a limited range of a few meters. The

system informs the user about any abnormal conditions like less moisture content and temperature rise, even concentration of carbon dioxide (CO₂) via Short Messaging System (SMS) from the GSM module. Although Bluetooth eliminates the usage cost of the network to a great extent, its range of operation is limited to a few meters. One cannot remotely monitor and control devices using this technology. It is desirable for each home device to have a dedicated Bluetooth module but due to the fiscal expense of this type of implementation, a single module is shared by several devices which has a disadvantage of access delay. Interference is also a problem when using this technology.

In [3], the proposed system for the greenhouse real time monitoring using Digital Signal Processor (DSP) has been implemented. The system was recorded the various environmental factors such as temperature, humidity, soil moisture contents, illumination, and carbon dioxide (CO₂) concentration. DSP based prototype systems are limited data storage capacity (32 bits, 1200 MHz speed), high power consumption, cost effective, no high flexibility and reusability, no easy upgrading (due to the usage of abstract hardware description language) but do provide only suboptimal processing speed due to the execution of software programs.

Fig. 2 shows a wireless sensor network (WSN) consists of spatially distributed autonomous sensors to monitor physically or environmental conditions, such as temperature, sound, vibration, pressure, motion or pollutants and to cooperatively pass their data through the network to a main location. WSN can be used in some special situation for signal collection, processing and transmitting. Wireless technologies have been rapidly developed during recent years. Its advantages include the liability, simplicity, and low cost in both installation and maintenance. WSN can form a useful part of the automation system architecture in modern greenhouse. Wireless communication can be used to collect the measurement and to communicate between the centralized control and the actuators located in the different parts of the greenhouse [2][4-5]. Compared to the cabled systems, the installation of WSN is fast, cheap and easy. Moreover, it is easy to relocate the measurement points when needed by just moving sensor nodes from one location to another within a communication range of the coordinator device. WSN maintenance is also relatively cheap and easy. The only additional cost occur when the sensor nodes run out of batteries and the batteries need to be charged or replaced, but the lifespan of the battery can be several years if an efficient power saving algorithm is applied. A wireless sensor network consists small size wireless sensor nodes equipped with radio and one or several sensors in an attractive and cost efficient option to build the required measurement system. Wireless technologies have been rapidly developed during recent years. There are a few types of wireless communication technologies which is ZigBee, Wi-Fi and Bluetooth. Wi-Fi, Bluetooth and Zigbee work at similar RF frequencies, and their application sometimes overlaps [2]. Table 1 shows the comparison between ZigBee, Wi-Fi and Bluetooth.

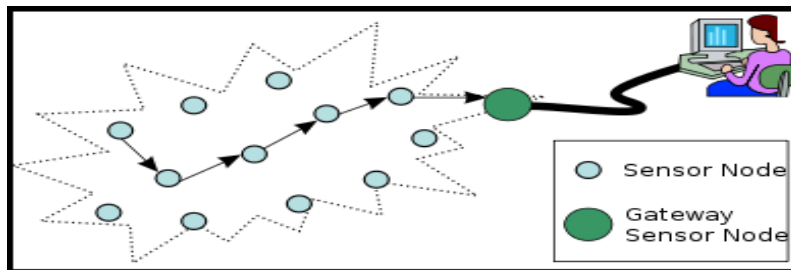

Figure 2. Typical multi-hop wireless sensor network architecture

Table 1. Comparison between ZigBee, Wi-Fi and Bluetooth [6]

Technology	ZigBee	Wi-Fi	Bluetooth
Application	Monitoring & Control	Web, Email, Video	Cable Replacement
System Resource	4kb – 32kb	1MB+	250KB+
Battery Life (Day)	100 – 1000+	5	1-7
Transmission Range (meter)	1- 100+	1-100	1-10
Source Metrics	Reliability, Power, Cost	Speed, Flexibility	Cost, Convenience

ZigBee is a low power wireless specification based on the Institute of Electrical and Electronics Engineers (IEEE) standard 802.15.4.2003 and was established in 2002 by a group of 16 companies. It introduces mesh networking to the low power wireless space and is targeted towards applications such as smart meters, home automation and remote controls [7]. ZigBee’s complexity and power requirements don’t make it particularly suitable for unmaintained devices that need to operate for extensive periods from a limited power source and the channel within 2MHz wide, however they are separated by 5MHz thus wasting spectrum somewhat. ZigBee is not a frequency hopping technology, it therefore requires careful planning during

deployment, to ensure no interferers are in the vicinity. There are three types of Zigbee offer in market, such XBee Series 1 that able to support up to 100 meters, XBee Series 2 that able to support until 125 meters and XBee Pro Series 1 able to support coverage up to 1.5 kilometers. In this paper, the XBee Series 1 is used because the greenhouse size is not large and can be built in the form of a network. Generally modern greenhouse has hundreds of square meters and they may plant a variety of plants depending on different seasons. The traditional system adopts wired way wiring, which makes the system complex and expensive [1][4].

Based on wireless sensor network technology for greenhouse, ZigBee offers flexibility and mobility to save cost and energy spent on wiring. There are five main factors of the greenhouse network to be comparing which are costly, data rate, number of nodes, current consumption and battery life [1]. As a whole, ZigBee technology offers long battery life, small size, high reliability, automatic or semi-automatic installation, and particularly, a low system cost. Therefore, it is a better choice for greenhouse monitoring and control than other wireless protocols.

II. DESIGN METHODOLOGY

The prototype of greenhouse monitoring using wireless sensor network consists of DC power supply, 9V, Zigbee, PIC Microcontroller 16F877A, LCD screen and temperature and humidity sensor. For hardware connection, to design the prototype it is all start with the configuration of Zigbee in order to make them communicate with each other. The temperature and humidity sensor that are connected with PIC will be interfaced and test the connection for each component to ensure that they working properly. Fig. 3 shows the block diagram of the development process for greenhouse monitoring using WSN.

In the software process, MPLAB software is used to design the connection and all the interface process. After that, the entire program that has been designed to connect with the PIC will be compiled together by using C Compiler program. Then, the hardware and the software were combined together to complete the prototype. The temperature and humidity sensor will collect the reading in the greenhouse. The data collected was sent to the microcontroller and the data were converted from analog to digital form. Then, the data were sent to the receiver through ZigBee wireless devices. ZigBee transmitter will send data to ZigBee receiver and the data was sent to the microcontroller again. The temperature and humidity reading that are collected from the greenhouse was displayed on the LCD screen.

A hardware development process is a structure imposed on the development of a hardware product which including Printed Circuit Board (PCB) design using Proteus software. Fig. 4 shows the circuit connection of the transmitter and receiver which used the same circuit. In this project, software developed using C Compiler. This program is able to receive data, interfaced component with microcontroller and stored the database. Temperature sensor, humidity sensor, ZigBee device and also LCD display were interfaced with the

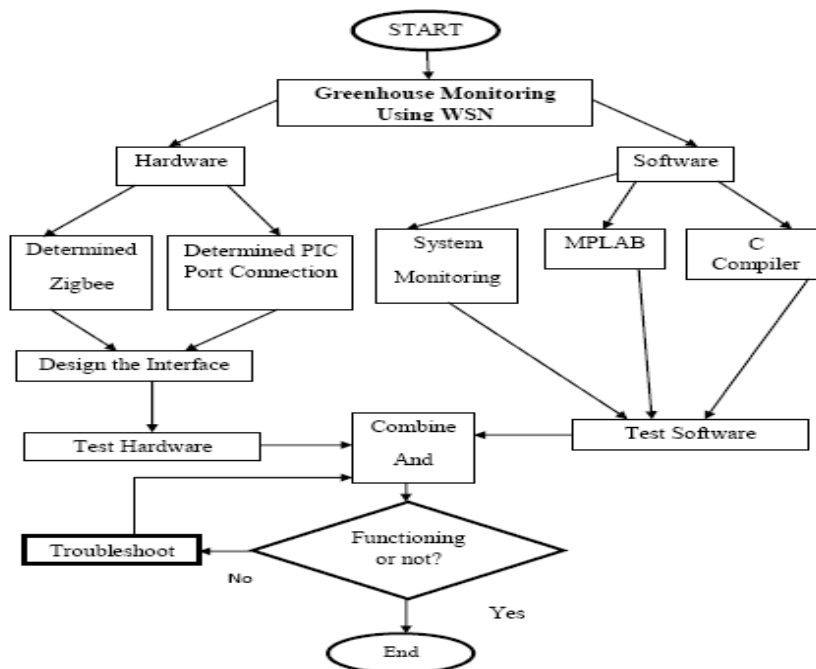

Figure 3. Development process of greenhouse monitoring using ZigBee

microcontroller by using C Compiler software. It will start from the greenhouse which the sensors will collect the data. The data collected are in analog form and will be converted into digital form by the ADC converter in the microcontroller by using MPLAB IDE. Then, the data were transmitted through ZigBee transmitter to ZigBee receiver. The data received was displayed on the LCD screen. Fig. 5 shows the interfacing between the LCD display and a PIC microcontroller. The last process involved in testing and check the availability of the overall system include the reader, architecture design, and the performance of the whole database system in response when required and fulfill the requirement of the system. Overall, this system function correctly as temperature and humidity in the greenhouse transmitted through wireless ZigBee and the data are monitored on the LCD display.

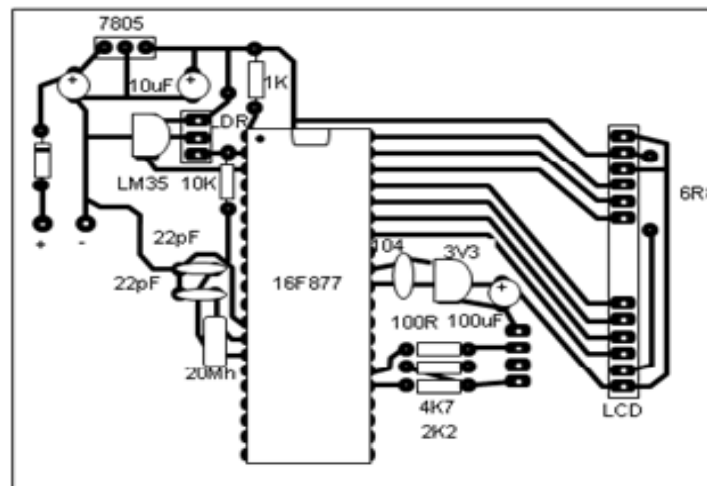

Figure 4. Transmitter & Receiver Circuit Printing Layout

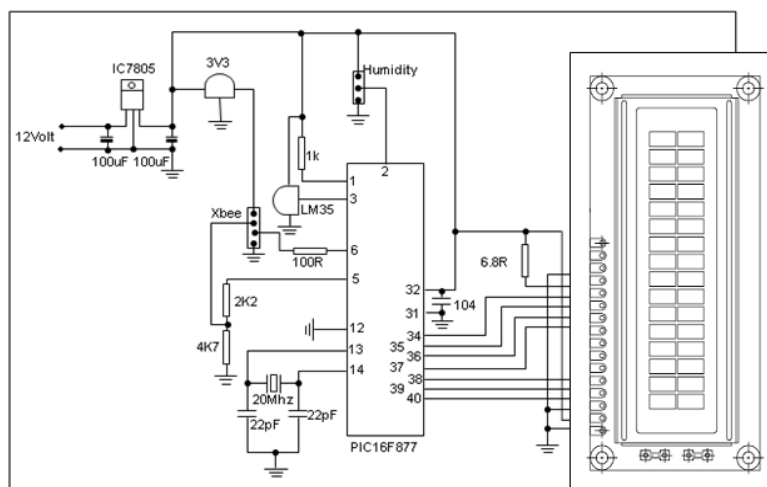

Figure 5. LCD Interface with PIC Microcontroller

III. RESULT AND ANALYSIS

The results and analysis is based on ZigBee connection test, ZigBee range test, interfacing result and data record of humidity and temperature.

A. ZigBee Connection Test

The XBee devices need to be configured before it can be used as a serial communication medium between the software and hardware and them to communicate with each others. For configuration it can be done by using X-CTU software as shown in Fig. 6. Every data transmit have no delay but error does occur sometimes and some data are lost at the receiving terminal. This could refer to the line of sight that might be occurred and interrupted by certain obstacles but the XBee module still could connect with each others. Next, the range has increased in order to check whether the Zigbee able to support a long distance and it was successfully done when the Zigbee could receive and transmit data on certain range.

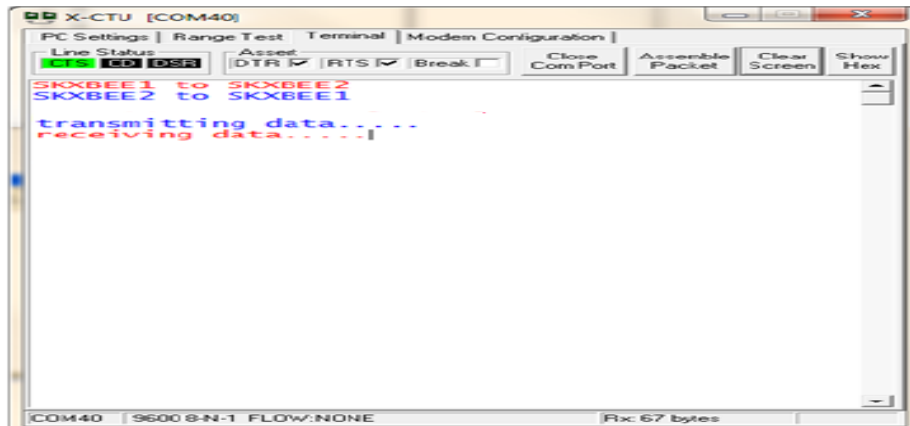

Figure 6. X-CTU Configuration

B. ZigBee Range Test

This process is to test how far the ZigBee transmitter can connect to Zigbee receiver. The distance of the ZigBee wireless on transmitter module and receiver module has its own limit which able to communicate within 100 meter range. During the process, the ZigBee received the data from the transmitter was very slow at the range between 60 meters to 100 meters. It was because the 9V battery could not support the long range and drain quickly than usual. It is because the range test was held in the open field that able the line of sight occurs. The wireless transmission of data by digital radio signals at a particular frequency. Wireless communication works by creating electromagnetic waves at a source and being able to send the electromagnetic waves at a particular destination. These electromagnetic waves travel through the air at near the speed of light [8]. The user does not need to lay cable all over the greenhouse because this product able to support a maximum range of 100 meters. This range test proved the wireless sensor network, Zigbee could allow in reducing the cabling system by supporting the long distance range. This method have also proved the Zigbee monitoring system support by locating the portable device in the hot spot place such as in the greenhouse.

C. Interfacing Result

MPLAB software is used to run the program to interface the sensors and the PIC microcontroller. Analog to Digital Converter (ADC) is used to convert the voltage from the sensors to the digital systems so that the result will be displayed on the LCD screen in digital form. From Fig. 7, the LCD screen shows the current reading of temperature and humidity that the sensors collected. The humidity reading is not stable because of the humidity in our environment is always changing and the temperature reading shows the stable data. For the limitation, PIC 16 series the microcontroller (PIC 16F877A) that is used has its own limitation in terms of memory to put many sensors or input.

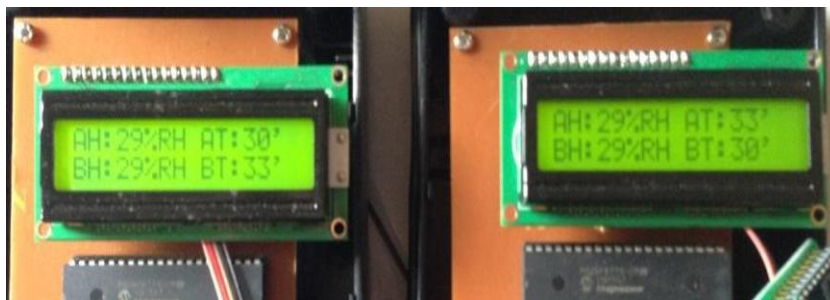

Figure 7. Humidity & Temperature Reading at the transmitter and receiver.

D. Data Record of Humidity and Temperature

The system had fully tested in the real greenhouse at the Agriculture Department of Melaka Tengah greenhouse. The range between ZigBee 1(transmitter) from ZigBee 2 (receiver) is about 22 meters which the ZigBee 1(transmitter) was located inside the greenhouse and ZigBee 2 (receiver) is supervised from the outside of the greenhouse. The data have been taken on 27th May 2013 from 08.00 am until 18.00 pm. Fig. 8 shows the graph of temperature versus time. The stable temperature in the greenhouse is 40° C. From the experiment, the reading in the greenhouse on that day is stable but at 15.00 pm, the temperature starts to drop because it was raining at that time. The temperature inside the greenhouse drops and maintain below 40° C.

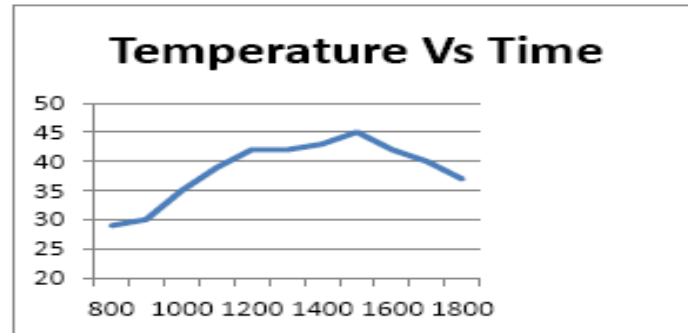

Figure 8. Graph of Temperature vs Time

For humidity condition as shown in Fig. 9, the stable reading is about 20% to 40%. On the experiment day, the humidity is in stable condition. When it starts raining, the humidity rises above 40% but still in a normal condition. Humidity is proportional to temperature which means, when the temperature is high, the humidity is low. They are capable to collect the environmental data with precise sensors and are able to transmit it to control station with high efficiency. In this greenhouse concept that was done Agriculture Department of Melaka Tengah, the chillies will need a high temperature and humidity to produce a high quality of chilly. So, the condition inside of this greenhouse for temperature and humidity are much higher than other kind of plants that used a greenhouse concept. Besides that, a ZigBee sensor network can use to maintain network performance at a high level despite the data rate that ZigBee could transmit is lower than Bluetooth or other wireless devices it still could support the sufficient data that was in monitoring greenhouse [9].

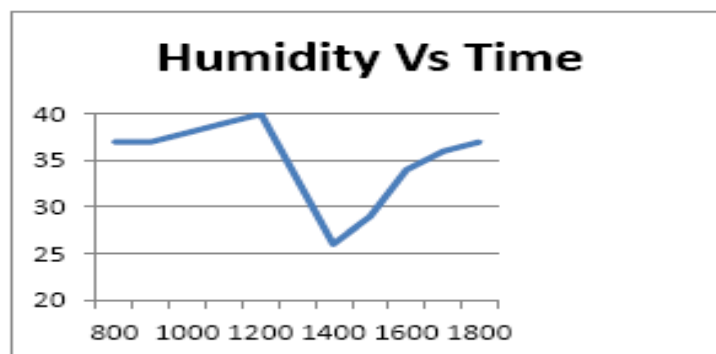

Figure 9. Graph of Humidity vs Time

IV. CONCLUSION

The low cost greenhouse monitoring was successfully developed using ZigBee technology as WSN. The system allows to monitor the condition of temperature and humidity which the temperature and humidity sensor successfully collected data in the greenhouse and send the data to the microcontroller. The data were sent from transmitter to receiver and LCD screen displayed the collected data and it is showing both sensor, temperature and humidity working properly for 100 meter range. C Compiler and MPLAB software were used for the programming and interfacing process. For the future work, the system can be improve in term of number of sensor using which able to monitor more parameter such as water level and control the condition in the greenhouse by build a maintenance system so that the greenhouse is always in a stable condition. Use a various topology of networking such as mesh or star topologies that could help in stabling the system for a large area of greenhouses. The wireless ZigBee transmitter and receiver module need a higher technology device for communication system so that the system can send the data in any long distance in bigger greenhouse site. The system needs to be built in compact designs to put in strategic places and reduce the interference signal in the greenhouse environment. Proper design of database management system can be implemented specifically to maintain and update all monitoring records and all future quantitative analysis such as using the Graphical Interfacing User (GUI).

V. ACKNOWLEDGEMENTS

The author would like to thank Universiti Teknikal Malaysia Melaka (UTeM) which has financially supported this research to be accomplished.

REFERENCES

- [1] Ling-ling Li, Shi-Feng Yang, Li-Yan Wang, and Xiang-Ming Gao., The Greenhouse Environment Monitoring System Based on Wireless Sensor Network Technology, *IEEE International Conference on Cyber Technology in Automation, Control, and Intelligent Systems*, March 2011.
- [2] Purnima and S.R.N. Reddy., "Design of Remote Monitoring and Control System with Automatic Irrigation System using GSM-Bluetooth,"*International Journal of Computer Application*, June 2012.
- [3] Anuj Kumar, Abhishek Singh, I. P. Singh, and S. K. Sud. Prototype Greenhouse Environment Monitoring System. *Proceedings Of The International Multiconference of Engineers and Computer Scientists 2010*. Vol II, IMECS 2010, March 17-19, 2010.
- [4] Teemu Ahonen, Reino Virrankoski and Mohammed Elmusrati, *Greenhouse Monitoring with Wireless Sensor Network*, Department of Computer Science Telecommunication Engineering Group. University of Vaasa, 2003.
- [5] H. Liu, Z. Meng and S. Cui., A Wireless Sensor Network Prototype for Environmental Monitoring in Greenhouse, *International Conference of Wireless Communications, Networking and Mobile Computing 2007 (WiCom 2007)*, September 2007, pp. 2344 – 2347.
- [6] Jin-Shyan Lee, Yu-Wei Su, and Chung-Chou Shen, Comparative Study of Wireless Protocols: Bluetooth, UWB, ZigBee, and Wi-Fi, *The 33rd Annual Conference of the IEEE Industrial Electronics Society (IECON)*, Nov 2007.
- [7] Phill Smith, Comparisons between Low Power Wireless Technologies, U.S Patent CS-213199-AN. 2011
- [8] Miss.Vrushali R. Deore, "Prof. V.M. Umale. Wireless Monitoring of the Green House System Using Embedded Controllers, *International Journal of Scientific & Engineering Research*, Volume 3. Issue 2, Feb 2012.
- [9] Muhammad Qayum Omar, Hashim Edin, Khairu Anuar Mohamed Zain, and Muhamad Azman Miskam, Preliminary Infrastructure Development for Greenhouse Accounting of Malaysian Rainforest Using Wireless Sensor Network, *European Journal of Scientific Research* , 2009, pp. 249-260.